

Intersection Graphs of L-Shapes and Segments in the Plane^{*}

Stefan Felsner¹, Kolja Knauer², George B. Mertzios³, and Torsten Ueckerdt⁴

¹ Institut für Mathematik, Technische Universität Berlin, Germany.

² LIRMM, Université Montpellier 2, France.

³ School of Engineering and Computing Sciences, Durham University, UK.

⁴ Department of Mathematics, Karlsruhe Institute of Technology, Germany.

felsner@math.tu-berlin.de, kolja.knauer@math.univ-montp2.fr,
george.mertzios@durham.ac.uk, torsten.ueckerdt@kit.edu

Abstract. An L-shape is the union of a horizontal and a vertical segment with a common endpoint. These come in four rotations: L, Γ , J and $\bar{\Gamma}$. A k -bend path is a simple path in the plane, whose direction changes k times from horizontal to vertical. If a graph admits an intersection representation in which every vertex is represented by an L, an L or Γ , a k -bend path, or a segment, then this graph is called an $\{L\}$ -graph, $\{L, \Gamma\}$ -graph, B_k -VPG-graph or SEG-graph, respectively. Motivated by a theorem of Middendorf and Pfeiffer [Discrete Mathematics, 108(1):365–372, 1992], stating that every $\{L, \Gamma\}$ -graph is a SEG-graph, we investigate several known subclasses of SEG-graphs and show that they are $\{L\}$ -graphs, or B_k -VPG-graphs for some small constant k . We show that all planar 3-trees, all line graphs of planar graphs, and all full subdivisions of planar graphs are $\{L\}$ -graphs. Furthermore we show that all complements of planar graphs are B_{19} -VPG-graphs and all complements of full subdivisions are B_2 -VPG-graphs. Here a full subdivision is a graph in which each edge is subdivided at least once.

Keywords: intersection graphs, segment graphs, co-planar graphs, k -bend VPG-graphs, planar 3-trees.

1 Introduction and Motivation

A **segment intersection graph**, SEG-graph for short, is a graph that can be represented as follows. Vertices correspond to straight-line segments in the plane and two vertices are adjacent if and only if the corresponding segments intersect. Such representations are called *SEG-representations* and, for convenience, the class of all SEG-graphs is denoted by SEG. SEG-graphs are an important subject of study strongly motivated from an algorithmic point of view. Indeed, having an intersection representation of a graph (in applications graphs often come

^{*} This work was partially supported by (i) the DFG ESF EuroGIGA projects COMPOSE and GraDR, (ii) the EPSRC Grant EP/K022660/1 and (iii) the ANR Project EGOS: ANR-12-JS02-002-01.

along with such a given representation) may allow for designing better or faster algorithms for optimization problems that are hard for general graphs, such as finding a maximum clique in interval graphs.

More than 20 years ago, Middendorf and Pfeiffer [24], considered intersection graphs of **axis-aligned L-shapes** in the plane, where an axis-aligned L-shape is the union of a horizontal and a vertical segment whose intersection is an endpoint of both. In particular, L-shapes come in four possible rotations: L , $\mathsf{\Gamma}$, J , and $\mathsf{\bar{L}}$. For a subset X of these four rotations, e.g., $X = \{\mathsf{L}\}$ or $X = \{\mathsf{L}, \mathsf{\Gamma}\}$, we call a graph an X -graph if it admits an X -representation, i.e., vertices can be represented by L-shapes from X in the plane, each with a rotation from X , such that two vertices are adjacent if and only if the corresponding L-shapes intersect. Similarly to SEG, we denote the class of all X -graphs by X . The question if an intersection representation with polygonal paths or pseudo-segments can be *stretched* into a SEG-representation is a classical topic in combinatorial geometry and Oriented Matroid Theory. Middendorf and Pfeiffer prove the following interesting relation between intersection graphs of segments and L-shapes.

Theorem 1 (Middendorf and Pfeiffer [24]). *Every $\{\mathsf{L}, \mathsf{\Gamma}\}$ -representation has a combinatorially equivalent SEG-representation.*

This theorem is best-possible in the sense that there are examples of $\{\mathsf{L}, \mathsf{\bar{L}}\}$ -graphs which are no SEG-graphs [7, 24], i.e., such $\{\mathsf{L}, \mathsf{\bar{L}}\}$ -representations cannot be stretched. We feel that Theorem 1, which of course implies that $\{\mathsf{L}, \mathsf{\Gamma}\} \subseteq \text{SEG}$, did not receive a lot of attention in the active field of SEG-graphs. In particular, one could use Theorem 1 to prove that a certain graph class \mathcal{G} is contained in SEG by showing that \mathcal{G} is contained in $\{\mathsf{L}, \mathsf{\Gamma}\}$. For example, very recently Pawlik *et al.* [25] discovered a class of triangle-free SEG-graphs with arbitrarily high chromatic number, disproving a famous conjecture of Erdős [18], and it is in fact easier to see that these graphs are $\{\mathsf{L}\}$ -graphs than to see that they are SEG-graphs. To the best of our knowledge, the stronger result $\mathcal{G} \subseteq \{\mathsf{L}, \mathsf{\Gamma}\}$ has never been shown for any non-trivial graph class \mathcal{G} . In this paper we initiate this research direction. We consider several graph classes which are known to be contained in SEG and show that they are actually contained in $\{\mathsf{L}\}$, which is a proper subclass of $\{\mathsf{L}, \mathsf{\Gamma}\}$ [7].

Whenever a graph is not known (or known not) to be an intersection graph of segments or axis-aligned L-shapes, one often considers natural generalizations of these intersection representations. Asinowski *et al.* [3] introduced **intersection graphs of axis-aligned k -bend paths** in the plane, called B_k -VPG-graphs. An (axis-aligned) k -bend path is a simple path in the plane, whose direction changes k times from horizontal to vertical. Clearly, B_1 -VPG-graphs are precisely intersection graphs of all four L-shapes; the union of B_k -VPG-graphs for all $k \geq 0$ is exactly the class STRING of intersection graphs of simple curves in the plane [3]. Now if a graph $G \notin \text{SEG}$ is a B_k -VPG-graph for some small k , then one might say that G is “not far from being a SEG-graph”.

Our Results and Related Work.

Let us denote the class of all planar graphs by PLANAR. A recent celebrated

result of Chalopin and Gonçalves [6] states that $\text{PLANAR} \subset \text{SEG}$, which was conjectured by Scheinerman [26] in 1984. However, their proof is rather involved and there is not much control over the kind of SEG-representations. Here we give an easy proof for a non-trivial subclass of planar graphs, namely *planar 3-trees*. A *3-tree* is an edge-maximal graph of treewidth 3. Every 3-tree can be built up starting from the clique K_4 and adding new vertices, one at a time, whose neighborhood in the so-far constructed graph is a triangle.

Theorem 2. *Every planar 3-tree is an $\{\text{L}\}$ -graph.*

It remains open to generalize Theorem 2 to planar graphs of treewidth 3 (i.e., subgraphs of planar 3-trees). On the other hand it is easy to see that graphs of treewidth at most 2 are $\{\text{L}\}$ -graphs [8]. Chaplick and the last author show in [9] that planar graphs are B_2 -VPG-graphs, improving on an earlier result of Asinowski *et al.* [3]. In [9] it is also conjectured that $\text{PLANAR} \subset \{\text{L}\}$, which with Theorem 1 would imply the main result of [6], i.e., $\text{PLANAR} \subset \text{SEG}$.

Considering line graphs of planar graphs, one easily sees that these graphs are SEG-graphs. Indeed, a straight-line drawing of a planar graph G can be interpreted as a SEG-representation of the line graph $L(G)$ of G , which has the edges of G as its vertices and pairs of incident edges as its edges. We prove the following strengthening result.

Theorem 3. *The line graph of every planar graph is an $\{\text{L}\}$ -graph.*

Kratochvíl and Kuběna [21] consider the class of all complements of planar graphs (co-planar graphs), CO-PLANAR for short. They show that CO-PLANAR are intersection graphs of convex sets in the plane, and ask whether $\text{CO-PLANAR} \subset \text{SEG}$. As the INDEPENDENT SET PROBLEM in planar graphs is known to be NP-complete [15], MAX CLIQUE is NP-complete for any graph class $\mathcal{G} \supseteq \text{CO-PLANAR}$, e.g., intersection graphs of convex sets. Indeed, the longstanding open question whether MAX CLIQUE is NP-complete for SEG [22] has recently been answered affirmatively by Cabello, Cardinal and Langerman [4] by showing that every planar graph has an even subdivision whose complement is a SEG-graph. The subdivision is essential in the proof of [4], as it still remains an open problem whether $\text{CO-PLANAR} \subset \text{SEG}$ [21]. The largest subclass of CO-PLANAR known to be in SEG is the class of complements of partial 2-trees [14]. Here we show that all co-planar graphs are “not far from being SEG-graphs”.

Theorem 4. *Every co-planar graph is a B_{19} -VPG graph.*

Theorem 4 implies that MAX CLIQUE is NP-complete for B_k -VPG-graphs with $k \geq 19$. On the other hand, the MAX CLIQUE problem for B_0 -VPG-graphs can be solved in polynomial time, while VERTEX COLORABILITY remains NP-complete but allows for a 2-approximation [3]. Middendorf and Pfeiffer [24] show that the complement of any *even subdivision* of any graph, i.e., every edge is subdivided with a non-zero even number of vertices, is an $\{\text{L}, \updownarrow\}$ -graph. This implies that MAX CLIQUE is NP-complete even for $\{\text{L}, \updownarrow\}$ -graphs.

We consider *full subdivisions* of graphs, that is, a subdivision H of a graph G where each edge of G is subdivided at least once. It is not hard to see that a full subdivision H of G is in **STRING** if and only if G is planar, and that if G is planar, then H is actually a **SEG**-graph. Here we show that this can be further strengthened, namely that H is in an **{L}**-graph. Moreover, we consider the complement of a full subdivision H of an arbitrary graph G , which is in **STRING** but not necessarily in **SEG**. Here, similar to the result of Middendorf and Pfeiffer [24] on even subdivisions we show that such a graph H is “not far from being **SEG**-graph”.

Theorem 5. *Let H be a full subdivision of a graph G .*

- (i) *If G is planar, then H is an **{L}**-graph.*
- (ii) *If G is any graph, then the complement of H is a B_2 -VPG-graph.*

The graph classes considered in this paper are illustrated in Figure 1. We shall prove Theorems 2, 3, 4 and 5 in Sections 2, 3, 4 and 5, respectively, and conclude with some open questions in Section 6. Due to lack of space, the full proof of Theorem 2 is given in the full version [13].

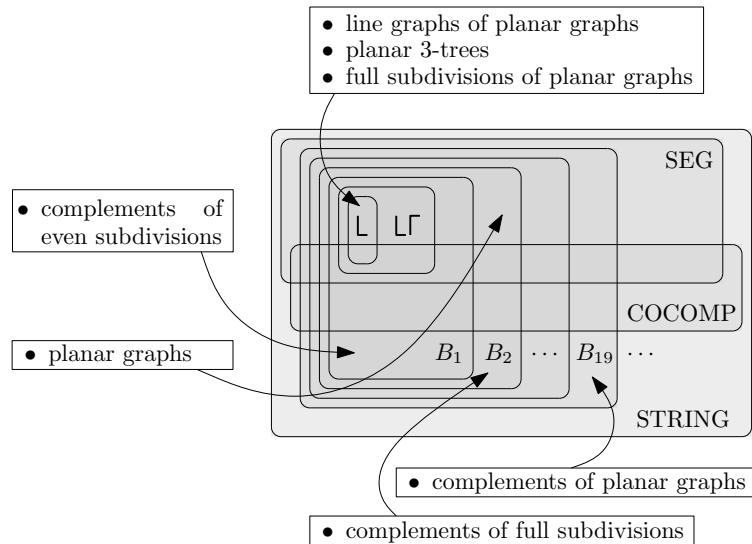

Fig. 1. Graph classes considered in this paper.

Related Representations.

In the context of *contact representations*, where distinct segments or k -bend paths may not share interior points, it is known that every contact **SEG**-representation has a combinatorially equivalent contact B_1 -VPG-representation,

but not vice versa [20]. Contact SEG-graphs are exactly planar Laman graphs and their subgraphs [10], which includes for example all triangle-free planar graphs. Very recently, contact $\{L\}$ -graphs have been characterized [8]. Necessary and sufficient conditions for stretchability of a contact system of pseudo-segments are known [1, 11].

Let us also mention the closely related concept of *edge*-intersection graphs of paths in a grid (EPG-graphs) introduced by Golumbic *et al.* [16]. There are some notable differences, starting from the fact that *every* graph is an EPG-graph [16]. Nevertheless, analogous questions to the ones posed about VPG-representations of STRING-graphs are posed about EPG-representations of general graphs. In particular, there is a strong interest in finding representations using paths with few bends, see [19] for a recent account.

2 Proof of Theorem 2

Proof (main idea). Let G be a plane 3-tree with a fixed plane embedding. We construct an $\{L\}$ -representation of G satisfying the additional property that for every inner triangular face $\{a, b, c\}$ of G there exists a subset of the plane, called the *private region* of the face, that intersects only the L-paths for a, b and c , and no other L-path. We remark that this technique has also been used by Chalopin *et al.* [5] and refer to Figure 2 for an illustration. \square

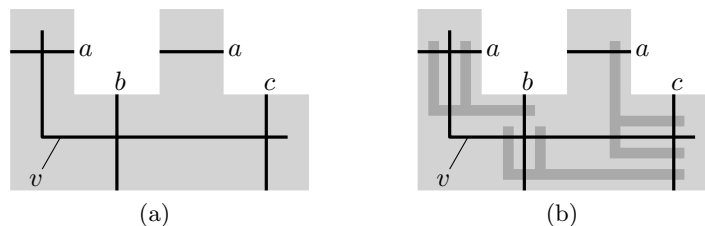

Fig. 2. (a) Introducing an L-shape for vertex v into the private region for the triangle $\{a, b, c\}$. (b) Identifying a pairwise disjoint private regions for the facial triangles $\{a, b, v\}$, $\{a, c, v\}$ and $\{b, c, v\}$.

3 Proof of Theorem 3

Proof. Without loss of generality let G be a maximally planar graph with a fixed plane embedding. (Line graphs of subgraphs of G are induced subgraphs of $L(G)$.) Then G admits a so-called *canonical ordering* –first defined in [12]–, namely an ordering v_1, \dots, v_n of the vertices of G such that

- Vertices v_1, v_2, v_n form the outer triangle of G in clockwise order. (We draw G such that v_1, v_2 are the highest vertices.)

- For $i = 3, \dots, n$ vertex v_i lies in the outer face of the induced embedded subgraph $G_{i-1} = G[v_1, \dots, v_{i-1}]$. Moreover, the neighbors of v_i in G_{i-1} form a path on the outer face of G_{i-1} with at least two vertices.

We shall construct an $\{\mathbf{L}\}$ -representation of $L(G)$ along a fixed canonical ordering v_1, \dots, v_n of G . For every $i = 2, \dots, n$ we shall construct an $\{\mathbf{L}\}$ -representation of $L(G_i)$ with the following additional properties.

For every outer vertex v of G_i we maintain an auxiliary bottomless rectangle $R(v)$, i.e., an axis-aligned rectangle with bottom-edge at $-\infty$, such that:

- $R(v)$ intersects the horizontal segments of precisely those rectilinear paths for edges in G_i incident to v .
- $R(v)$ does not contain any bends or endpoints of any path for an edge in G_i and does not intersect any $R(w)$ for $w \neq v$.
- the left-to-right order of the bottomless rectangles matches the order of vertices on the counterclockwise outer v_1, v_2 -path of G_i .

The bottomless rectangles act as placeholders for the upcoming vertices of $L(G)$. Indeed, all upcoming intersections of paths will be realized inside the corresponding bottomless rectangles. For $i = 2$, the graph G_i consist only of the edge v_1v_2 . Hence an $\{\mathbf{L}\}$ -representation of the one-vertex graph $L(G_2)$ consists of only one L-shape and two disjoint bottomless rectangles $R(v_1), R(v_2)$ intersecting its horizontal segment.

For $i \geq 3$, we shall start with an $\{\mathbf{L}\}$ -representation of $L(G_{i-1})$. Let (w_1, \dots, w_k) be the counterclockwise outer path of G_{i-1} that corresponds to the neighbors of v_i in G_{i-1} . The corresponding bottomless rectangles $R(w_1), \dots, R(w_k)$ appear in this left-to-right order. See Figure 3 for an illustration. For every edge v_iw_j , $j = 1, \dots, k$ we define an L-shape $P(v_iw_j)$ whose vertical segment is contained in the interior of $R(w_j)$ and whose horizontal segment ends in the interior of $R(w_k)$. Moreover, the upper end and lower end of the vertical segment of $P(v_iw_j)$ lies on the top side of $R(w_j)$ and below all L-shapes for edges in G_{i-1} , respectively. Finally, the bend and right end of $P(v_iw_j)$ is placed above the bend of $P(v_iw_{j+1})$ and to the right of the right end of $P(v_iw_{j+1})$ for $j = 1, \dots, k - 1$, see Figure 3.

It is straightforward to check that this way we obtain an $\{\mathbf{L}\}$ -representation of $L(G_i)$. So it remains to find a set of bottomless rectangles, one for each outer vertex of G_i , satisfying our additional property. We set $R'(v) = R(v)$ for every $v \in V(G_i) \setminus \{v_i, w_1, \dots, w_k\}$ since these are kept unchanged. Since $R(w_1)$ and $R(w_k)$ are not valid anymore, we define a new bottomless rectangle $R'(w_1) \subset R(w_1)$ such that $R'(w_1)$ is crossed by all horizontal segments that cross $R(w_1)$ and additionally the horizontal segment of $P(v_iw_1)$. Similarly, we define $R'(w_k) \subset R(w_k)$. And finally, we define a new bottomless rectangle $R'(v_i) \subset R(w_k)$ in such a way that it is crossed by the horizontal segments of exactly $P(v_iw_1), \dots, P(v_iw_k)$. Note that for $1 < j < k$ the outer vertex w_j of G_{i-1} is not an outer vertex of G_i . Then $\{R'(v) \mid v \in v(G_i)\}$ has the desired property. See again Figure 3. \square

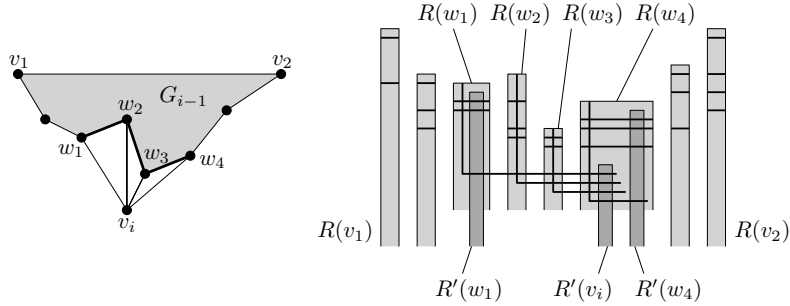

Fig. 3. Along a canonical ordering a vertex v_i is added to G_{i-1} . For each edge between v_i and a vertex in G_{i-1} an L-shape is introduced with its vertical segment in the corresponding bottomless rectangle. The three new bottomless rectangles $R'(w_1), R'(v_i), R'(w_k)$ are highlighted.

4 Proof of Theorem 4

Proof. Let $G = (V, E)$ be any planar graph. We shall construct a B_k -VPG representation of the complement \bar{G} of G for some constant k that is independent of G . Indeed, $k = 19$ is enough. To find the VPG representation we make use of two crucial properties of G : A) G is 4-colorable and B) G is 5-degenerate. Indeed, our construction gives a B_{2d+9} -VPG representation for the complement of any 4-colorable d -degenerate graph. Here a graph is called *d-degenerate* if it admits a vertex ordering such that every vertex has at most d neighbors with smaller index.

Consider any 4-coloring of G with color classes V_1, V_2, V_3, V_4 . Further let $\sigma = (v_1, \dots, v_n)$ be an order of the vertices of V witnessing the degeneracy of G , i.e., for each v_i there are at most 5 neighbors v_j of v_i with $j < i$. We call these neighbors the *back neighbors* of v_i . Consider any ordered pair of color classes, say (V_1, V_2) , and denote $W = V_1 \cup V_2$, together with the vertex orders inherited from the order of vertices in V , i.e., $\sigma|_{V_1} = \sigma_1 = (v_1, \dots, v_{|V_1|})$ and $\sigma|_{V_2} = \sigma_2 = (w_1, \dots, w_{|V_2|})$. Further consider the axis-aligned rectangle $R = [0, A] \times [0, A]$, where $A = 2(|W| + 2)$. For illustration we divide R into four quarters $[0, A/2] \times [0, A/2]$, $[0, A/2] \times [A/2, A]$, $[A/2, A] \times [0, A/2]$ and $[A/2, A] \times [A/2, A]$. We define a monotone increasing path $Q(v)$ for each $v \in W$ as follows. See Figure 4 for an illustration.

- For $v \in V_1$ let $\{\sigma_2(i_1), \dots, \sigma_2(i_k)\}$, $i_1 < \dots < i_k$, be the back neighbors of v in V_2 and $i^* = \max\{0\} \cup \{\sigma_2^{-1}(w) \mid w \in V_2, \sigma^{-1}(w) < \sigma^{-1}(v)\}$ be the largest index with respect to σ_2 of a vertex in V_2 that comes before v in σ or $i^* = 0$ if there is no such vertex. Then we define the path $Q(v)$ so that it starts at $(1, 0)$, uses the horizontal lines at $y = 2i_j - 1$ for $j = 1, \dots, k$, $y = 2i^* + 1$ and $y = A - 2\sigma_1(v)$ in that order, uses the vertical lines at $x = 1$, $x = 2i_j + 1$ for $j = 1, \dots, k$ and $x = A - 2\sigma_1(v)$ in that order, and finally ends at $(A, A - 2\sigma_1(v))$.

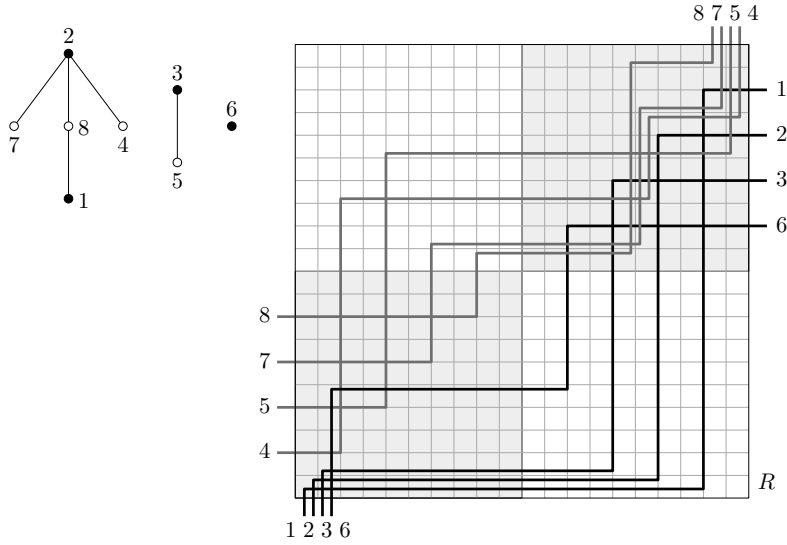

Fig. 4. The induced subgraph $G[W]$ for two color classes $W = V_1 \cup V_2$ of a planar graph G and a VPG representation of its complement $\bar{G}[W]$ in the rectangle $[0, 2(|W| + 2)] \times [0, 2(|W| + 2)]$.

Note that $Q(v)$ avoids the top-left quarter of R , has exactly one bend at $(A - 2\sigma_1(v), A - 2\sigma_1(v))$ in the top-right quarter, and goes above the point $(2i, 2i)$ in the bottom-left quarter if and only if $i \neq i_1, \dots, i_k$ and $i \leq i^*$.

- For $w_i \in V_2$ the path $P(w_i)$ is defined analogous after rotating the rectangle R by 180 degrees and swapping the roles of V_1 and V_2 .

It is straightforward to check that $\{Q(v) \mid v \in W\}$ is a VPG representation of $\bar{G}[W]$ completely contained in R , where each $Q(v)$ starts and ends at the boundary of R and has at most $3 + 2k$ bends, where k is the number of back neighbors of v in W .

Now we have defined for each pair of color classes $V_i \cup V_j$ a VPG-representation of $\bar{G}[V_i \cup V_j]$. For every vertex $v \in V$ we have defined three Q -paths, one for each color class that v is not in. In total the three Q -paths for the same vertex v have at most $9 + 2k \leq 19$ bends, where $k \leq 5$ is the back degree of v . It remains to place the six representations of $\bar{G}[V_i \cup V_j]$ non-overlapping and to “connect” the three Q -paths for each vertex in such a way that connections for vertices of different color do not intersect. This can easily be done with two extra bends per paths, basically because K_4 is planar (we refer to Figure 5 for one way to do this). Finally, note that the first and last segment of every path in the representation can be omitted, yielding the claimed bound. \square

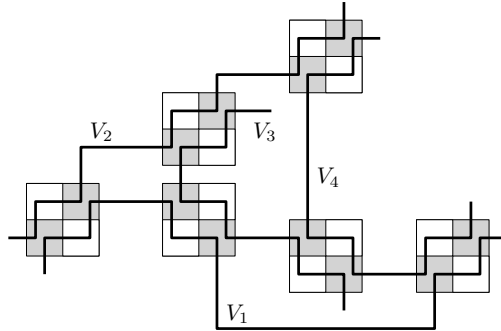

Fig. 5. Interconnecting the VPG representations of $\bar{G}[V_i \cup V_j]$ by adding at most two bends for each vertex. The set of paths corresponding to color class V_i is indicated by a single path labeled V_i , $i = 1, 2, 3, 4$.

5 Proof of Theorem 5

Proof. Let G be any graph and H arise from G by subdividing each edge at least once. Without loss of generality we may assume that every edge of G is subdivided exactly once or twice. Indeed, if an edge e of G is subdivided three times or more, then H can be seen as a full subdivision of the graph G' that arises from G by subdividing e once.

- (i) Assuming that G is planar, we shall find an $\{L\}$ -representation of H as follows. Without loss of generality G is maximally planar. We consider a bar visibility representation of G , i.e., vertices of G are disjoint horizontal segments in the plane and edges are disjoint vertical segments in the plane whose endpoints are contained in the two corresponding vertex segments and which are disjoint from all other vertex segments. Such a representation for a planar triangulation exists e.g. by [23]. See Figure 6 for an illustration.

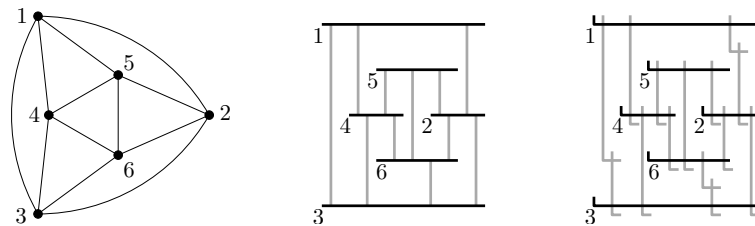

Fig. 6. A planar graph G on the left, a bar visibility representation of G in the center, and an $\{L\}$ -representation of a full division of G on the right. Here, the edges $\{1, 2\}$, $\{1, 3\}$ and $\{3, 6\}$ are subdivided twice.

It is now easy to interpret every segment as an L, and replace an segment corresponding to edge that is subdivided twice by two L-shapes. Let us simply refer to Figure 6 again.

- (ii) Now assume that $G = (V, E)$ is any graph. We shall construct a B_2 -VPG representation of the complement \bar{H} of $H = (V \cup W, E')$ with monotone increasing paths only. First, we represent the clique $\bar{H}[V]$. Let $V = \{v_1, \dots, v_n\}$ and define for $i = 1, \dots, n$ the 2-bend path $P(v_i)$ for vertex v_i to start at $(i, 0)$, have bends at (i, i) and $(i+n, i)$, and end at $(i+n, n+1)$. See Figure 7 for an illustration. For convenience, let us call these paths v -paths.

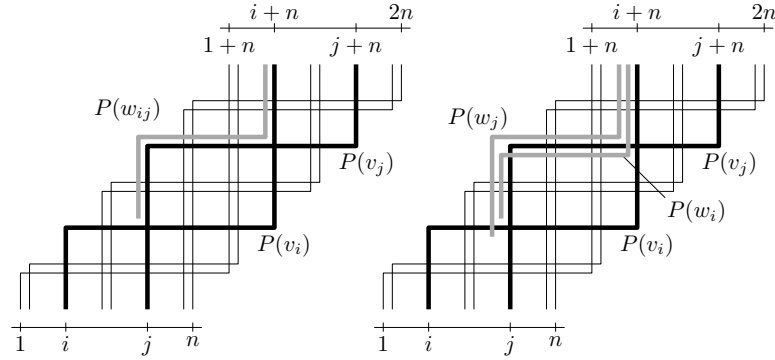

Fig. 7. Left: Inserting the path $P(w_{ij})$ for a single vertex w_{ij} subdividing the edge $v_i v_j$ in G . Right: Inserting the paths $P(w_i)$ and $P(w_j)$ for two vertices w_i, w_j subdividing the edge $v_i v_j$ in G .

Next, we define for every edge of G the 2-bend paths for the one or two corresponding subdivision vertices in \bar{H} . We call these paths w -paths. So let $v_i v_j$ be any edge of G with $i < j$. We distinguish two cases.

- Case 1.* The edge $v_i v_j$ is subdivided by only one vertex w_{ij} in H . We define the w -path $P(w_{ij})$ to start at $(j - \frac{1}{4}, i + \frac{1}{4})$, have bends at $(j - \frac{1}{4}, j + \frac{1}{4})$ and $(i + n - \frac{1}{4}, j + \frac{1}{4})$, and end at $(i + n - \frac{1}{4}, n + 1)$, see the left of Figure 7.
- Case 2.* The edge $v_i v_j$ is subdivided by two vertices w_i, w_j with $v_i w_i, v_j w_j \in E(H)$. We define the start, bends and end of the w -path $P(w_i)$ to be $(j - \frac{1}{4}, i + \frac{1}{4})$, $(j - \frac{1}{4}, j - \frac{1}{4})$, $(i + n - \frac{1}{4}, j - \frac{1}{4})$ and $(i + n - \frac{1}{4}, n + 1)$, respectively. The start, bends and end of the w -path $P(w_j)$ are $(j - \frac{1}{2}, i - \frac{1}{4})$, $(j - \frac{1}{2}, j + \frac{1}{4})$, $(i + n - \frac{1}{2}, j + \frac{1}{4})$ and $(i + n - \frac{1}{2}, n + 1)$, respectively. See the right of Figure 7.

It is easy to see that every w -path $P(w)$ intersects every v -path, except for the one or two v -paths corresponding to the neighbors of w in H . Moreover, the two w -paths in Case 2 are disjoint. It remains to check that the w -paths for distinct edges of G mutually intersect. To this end, note that every w -path for edge $v_i v_j$ starts near (j, i) , bends near (j, j) and $(i+n, j)$ and ends near $(i+n, n)$. Consider two w -paths P and P' that start at (j, i) and (j', i') ,

respectively, and bend near (j, j) and (j', j') , respectively. If $j = j'$ then it is easy to check that P and P' intersect near (j, j) . Otherwise, let $j' > j$. Now if $j > i'$, then P and P' intersect near (j', i) , and if $j \leq i'$, then P and P' intersect near $(i + n, j')$.

Hence we have found a B_2 -VPG-representation of \bar{H} , as desired. Let us remark, that in this representation some w -paths intersect non-trivially along some horizontal or vertical lines, i.e., share more than a finite set of points. However, this can be omitted by a slight and appropriate perturbation of endpoints and bends of w -paths. \square

6 Conclusions and Open Problems

Motivated by Middendorf and Pfeiffer's theorem (Theorem 1 in [24]) that every $\{\mathbb{L}, \Gamma\}$ -representation can be stretched into a SEG-representation, we considered the question which subclasses of SEG-graphs are actually $\{\mathbb{L}, \Gamma\}$ -graphs, or even $\{\mathbb{L}\}$ -graphs. We proved that this is indeed the case for several graph classes related to planar graphs. We feel that the question whether $\text{PLANAR} \subset \{\mathbb{L}, \Gamma\}$, as already conjectured [9], is of particular importance. After all, this, together with Theorem 1, would give a new proof for the fact that $\text{PLANAR} \subset \text{SEG}$.

Open Problem 1 *Each of the following is open.*

- (i) *When can a B_1 -VPG-representation be stretched into a combinatorially equivalent SEG-representation?*
- (ii) *Is $\{\mathbb{L}, \Gamma\} = \text{SEG} \cap B_1\text{-VPG}$?*
- (iii) *Is every planar graph an $\{\mathbb{L}\}$ -graph, or B_1 -VPG-graph?*
- (iv) *Does every planar graph admit an even subdivision whose complement is an $\{\mathbb{L}\}$ -graph, or B_1 -VPG-graph?*
- (v) *Recognizing B_k -VPG graphs is known to be NP-complete for each $k \geq 0$ [7]. What is the complexity of recognizing $\{\mathbb{L}\}$ -graphs, or $\{\mathbb{L}, \Gamma\}$ -graphs?*

References

1. N. Aerts and S. Felsner. Straight line triangle representations. In *Proceedings of the 21st International Symposium on Graph Drawing (GD)*, pages 119–130, 2013.
2. N. Alon and E. Scheinerman. Degrees of freedom versus dimension for containment orders. *Order*, 5:11–16, 1988.
3. A. Asinowski, E. Cohen, M. C. Golumbic, V. Limouzy, M. Lipshteyn, and M. Stern. Vertex intersection graphs of paths on a grid. *J. Graph Algorithms Appl.*, 16(2):129–150, 2012.
4. S. Cabello, J. Cardinal, and S. Langerman. The clique problem in ray intersection graphs. *Discrete & Computational Geometry*, 50(3):771–783, 2013.
5. J. Chalopin, D. Gonçalves, and P. Ochem. Planar graphs have 1-string representations. *Discrete Comput. Geom.*, 43(3):626–647, 2010.
6. J. Chalopin and D. Gonçalves. Every planar graph is the intersection graph of segments in the plane: extended abstract. In *Proceedings of the 41st annual ACM symposium on Theory of computing*, STOC '09, pages 631–638, 2009.

7. S. Chaplick, V. Jelínek, J. Kratochvíl, and T. Vyskočil. Bend-bounded path intersection graphs: Sausages, noodles, and waffles on a grill. In *Proceedings of the 38th Graph-Theoretic Concepts in Computer Science (WG)*, pages 274–285, 2012.
8. S. Chaplick, S. G. Kobourov, and T. Ueckerdt. Equilateral L-contact graphs. In *Proceedings of the 39th Graph-Theoretic Concepts in Computer Science (WG)*, pages 139–151, 2013.
9. S. Chaplick and T. Ueckerdt. Planar graphs as VPG-graphs. *Journal of Graph Algorithms and Applications*, 17(4):475–494, 2013.
10. H. de Fraysseix and P. O. de Mendez. Representations by contact and intersection of segments. *Algorithmica*, 47(4):453–463, 2007.
11. H. de Fraysseix and P. O. de Mendez. Stretching of Jordan arc contact systems. *Discrete Applied Mathematics*, 155(9):1079–1095, 2007.
12. H. De Fraysseix, J. Pach, and R. Pollack. How to draw a planar graph on a grid. *Combinatorica*, 10(1):41–51, 1990.
13. S. Felsner, K. Knauer, G. B. Mertzios, and T. Ueckerdt. Intersection graphs of L-shapes and segments in the plane. *arXiv preprint arXiv:1405.1476*, 2014.
14. M. C. Francis, J. Kratochvíl, and T. Vyskočil. Segment representation of a subclass of co-planar graphs. *Discrete Mathematics*, 312(10):1815–1818, 2012.
15. M. R. Garey and D. S. Johnson. *Computers and Intractability: A guide to the theory of NP-completeness*. W. H. Freeman, 1979.
16. M. C. Golumbic, M. Lipshteyn, and M. Stern. Edge intersection graphs of single bend paths on a grid. *Networks*, 54(3):130–138, 2009.
17. M. C. Golumbic, D. Rotem, and J. Urrutia. Comparability graphs and intersection graphs. *Discrete Mathematics*, 43(1):37–46, 1983.
18. A. Gyárfás. Problems from the world surrounding perfect graphs. *Zastos. Mat*, 19(3-4):413–441, 1987.
19. D. Heldt, K. Knauer, and T. Ueckerdt. Edge-intersection graphs of grid paths: The bend-number. *Discrete Appl. Math.*, 167:144–162, 2014.
20. S. G. Kobourov, T. Ueckerdt, and K. Verbeek. Combinatorial and geometric properties of planar Laman graphs. In *SODA*, pages 1668–1678. SIAM, 2013.
21. J. Kratochvíl and A. Kuběna. On intersection representations of co-planar graphs. *Discrete Math.*, 178(1-3):251–255, 1998.
22. J. Kratochvíl and J. Matousek. Intersection graphs of segments. *Journal of Combinatorial Theory, Series B*, 62(2):289–315, 1994.
23. F. Luccio, S. Mazzone, and C. K. Wong. A note on visibility graphs. *Discrete Math.*, 64(2-3):209–219, 1987.
24. M. Middendorf and F. Pfeiffer. The max clique problem in classes of string-graphs. *Discrete mathematics*, 108(1):365–372, 1992.
25. A. Pawlik, J. Kozik, T. Krawczyk, M. Lasoń, P. Micek, W. T. Trotter, and B. Walczak. Triangle-free intersection graphs of line segments with large chromatic number. *Journal of Combinatorial Theory, Series B*, 2013.
26. E. R. Scheinerman. *Intersection classes and multiple intersection parameters of graphs*. PhD thesis, Princeton University, 1984.
27. H. E. Warren. Lower bounds for approximation by nonlinear manifolds. *Trans. Amer. Math. Soc.*, 133:167–178, 1968.